

# Technical Information

SONATA 40x80x80

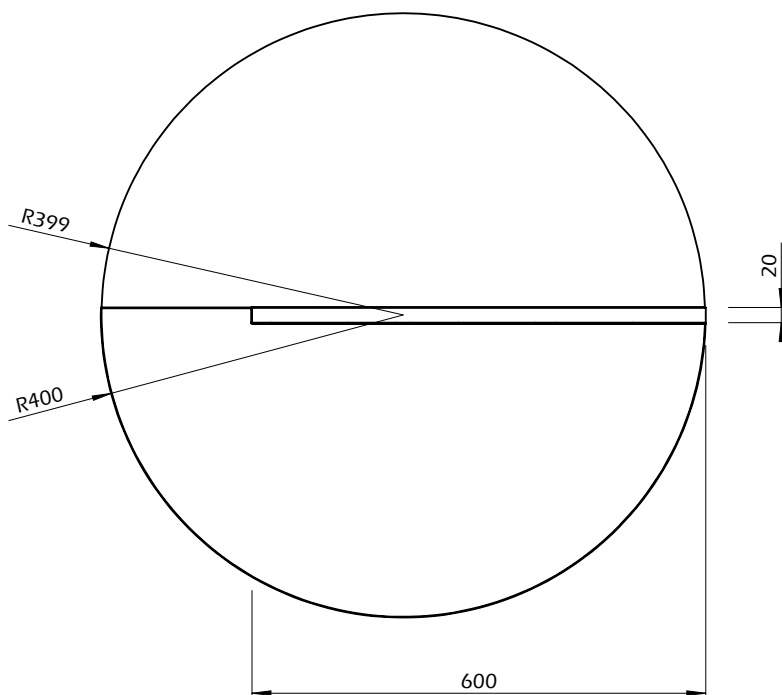

25min

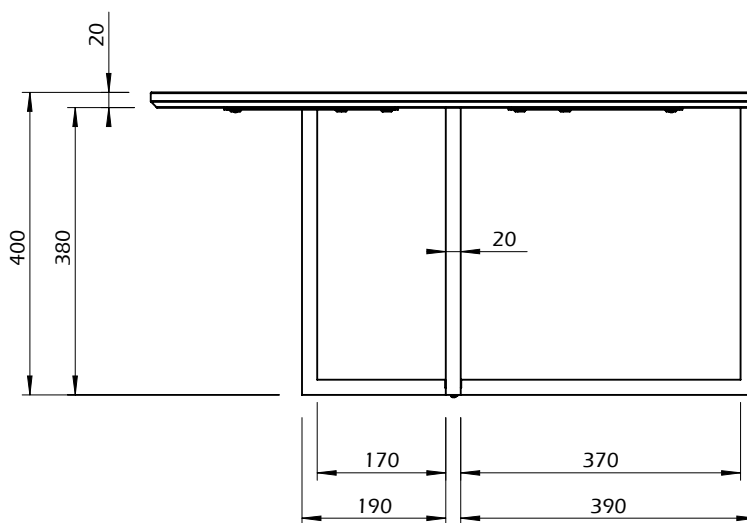
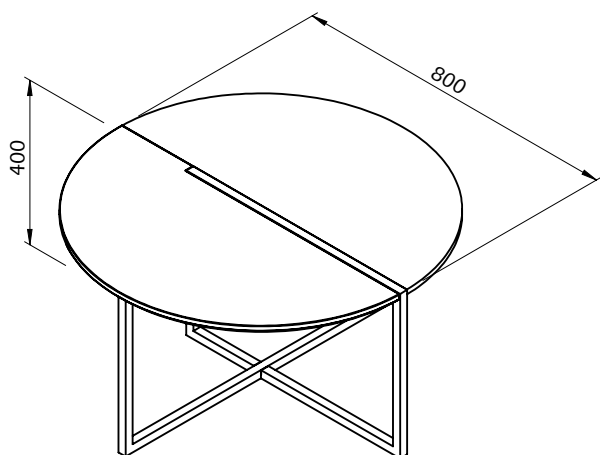

8kg